

BEGINNER  
SKILL

# Twinkle Lights

designed by Natalie Crabtree

featuring the *Snow Day* and *Diamond Dust* Collections by Whistler Studios

SIZE: 67" x 81"

FREE  
PROJECT

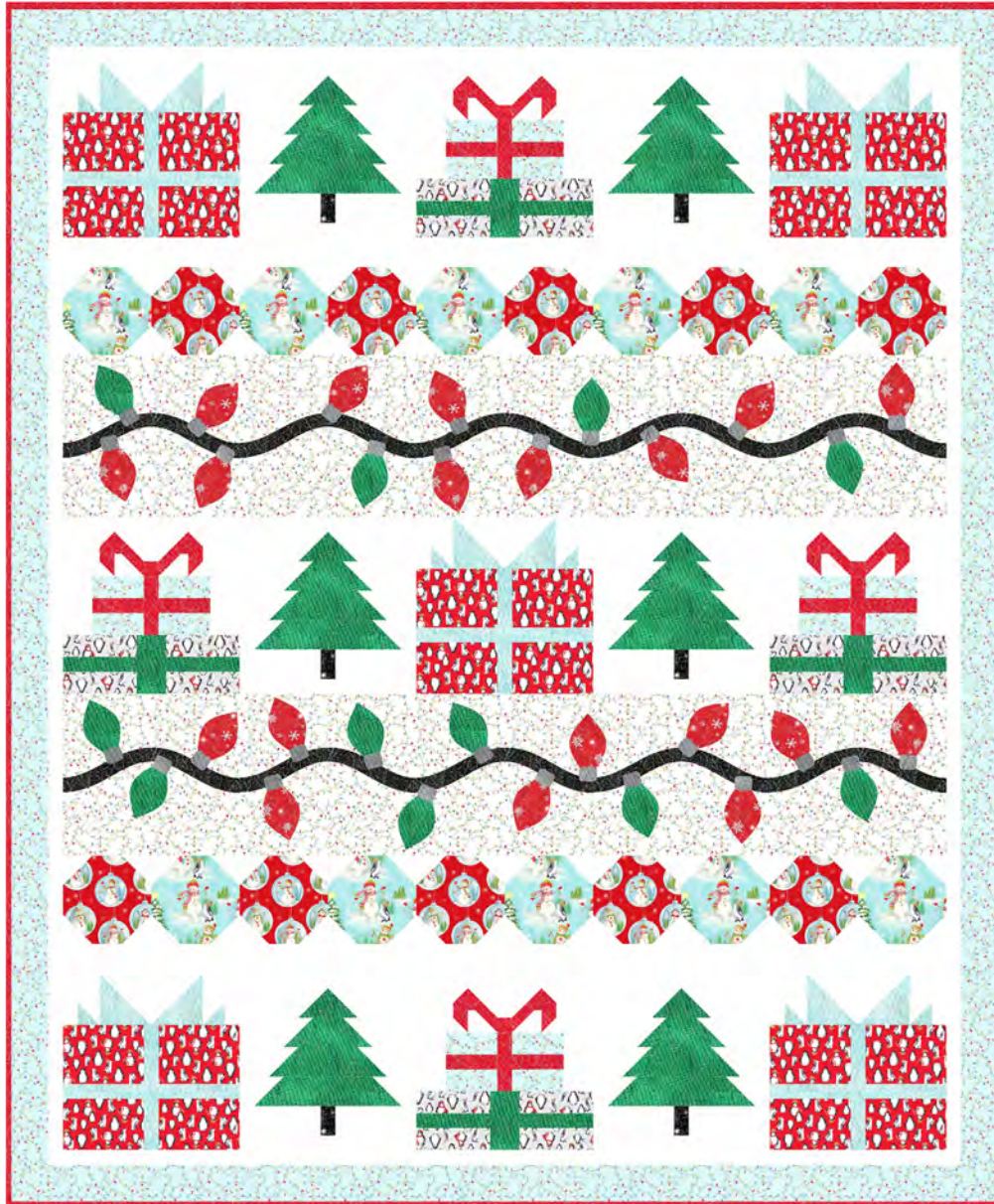





THIS IS A DIGITAL REPRESENTATION OF THE QUILT TOP, FABRIC MAY VARY.

**PLEASE NOTE:** BEFORE MAKING YOUR PROJECT, CHECK FOR ANY PATTERN UPDATES AT WINDHAMFABRICS.COM'S FREE PROJECTS SECTION.



# Twinkle Lights

Divide cut fabric pieces by block type for organization. Instructions included in this pattern are for raw edge applique. Reference the template pages for future details on applique completion.

KEY	FABRIC	SKU	YD	CUTTING INSTRUCTIONS
A		WINDHAM SOLIDS 31835S-Linen White	2 $\frac{1}{4}$	<p>(8) 1 <math>\frac{1}{2}</math>" x WOF strips. Piece strips for length using diagonal seams. From the long strip, subcut the following:</p> <ul style="list-style-type: none"> <li>(2) 1 <math>\frac{1}{2}</math>" x 74 <math>\frac{1}{2}</math>" Side Inner Borders.</li> <li>(2) 1 <math>\frac{1}{2}</math>" x 62 <math>\frac{1}{2}</math>" Top/Bottom Inner Borders.</li> </ul> <p>(3) 2 <math>\frac{1}{2}</math>" x WOF strips. Piece strips for length using diagonal seams. From the long strip, subcut (2) 2 <math>\frac{1}{2}</math>" x 60 <math>\frac{1}{2}</math>" horizontal sashing strips.</p> <p>(13) 2 <math>\frac{1}{2}</math>" x WOF strips. Subcut the following:</p> <ul style="list-style-type: none"> <li>(80) 2 <math>\frac{1}{2}</math>" squares for Block A.</li> <li>(12) 2 <math>\frac{1}{2}</math>" x 1 <math>\frac{1}{2}</math>" rectangles for Block B.</li> <li>(60) 2 <math>\frac{1}{2}</math>" squares for Block B.</li> <li>(12) 2 <math>\frac{1}{2}</math>" x 3 <math>\frac{1}{2}</math>" rectangles for Block B.</li> <li>(12) 2 <math>\frac{1}{2}</math>" x 4 <math>\frac{1}{2}</math>" rectangles for Block B.</li> <li>(12) 2 <math>\frac{1}{2}</math>" x 6" rectangles for Block B.</li> <li>(8) 2 <math>\frac{1}{2}</math>" x 4 <math>\frac{1}{2}</math>" rectangles for Block D.</li> <li>(8) 2 <math>\frac{1}{2}</math>" x 3" rectangles for Block D.</li> <li>(8) 2 <math>\frac{1}{2}</math>" x 2" rectangles for Block D.</li> </ul> <p>(4) 1 <math>\frac{1}{2}</math>" x WOF strips. Subcut the following:</p> <ul style="list-style-type: none"> <li>(12) 1 <math>\frac{1}{2}</math>" x 12 <math>\frac{1}{2}</math>" rectangles for Block B.</li> <li>(4) 1 <math>\frac{1}{2}</math>" x 3 <math>\frac{1}{2}</math>" rectangles for Block D.</li> <li>(24) 1 <math>\frac{1}{2}</math>" squares for Block D.</li> </ul> <p>(1) 1" x WOF strip. Subcut (8) 1" squares for Block D.</p> <p>(2) 4 <math>\frac{1}{2}</math>" x WOF strips. Subcut the following:</p> <ul style="list-style-type: none"> <li>(5) 4 <math>\frac{1}{2}</math>" squares for Block C.</li> <li>(8) 4 <math>\frac{1}{2}</math>" x 3" rectangles for Block D.</li> </ul> <p>(1) 4" x WOF strip. Subcut the following:</p> <ul style="list-style-type: none"> <li>(10) 4" x 2" rectangles for Block C.</li> <li>(10) 4" x 1 <math>\frac{1}{2}</math>" rectangles for Block C.</li> </ul>
B		SNOW DAY 52596D-1 Ice Blue	$\frac{1}{2}$	From yardage, fussy cut (10) 6 $\frac{1}{2}$ " squares for Block A.
C		SNOW DAY 52597D-2 Red	$\frac{1}{2}$	From yardage, fussy cut (10) 6 $\frac{1}{2}$ " squares for Block A.
D		SNOW DAY 52598D-2 Red	$\frac{3}{8}$	Using the available yardage, fuse (19) Template A pieces onto the wrong side of fabric. Cut out templates on the traced line and set aside for Applique Block assembly.
E		SNOW DAY 52598D-4 Night	$\frac{1}{8}$	(1) 1 $\frac{1}{2}$ " x WOF strip. Subcut (6) 1 $\frac{1}{2}$ " x 2 $\frac{1}{2}$ " rectangles for Block B.



# Twinkle Lights

F		SNOW DAY 52599D-2 Red	$\frac{5}{8}$	(2) 4" x WOF strips. Subcut (10) 4" x 6" rectangles for Block C. (2) 4 ½" x WOF strips. Subcut (10) 4 ½" x 6" rectangles for Block C.
G		SNOW DAY 52599D-5 Snow	$\frac{1}{4}$	(2) 2" x WOF strips. Subcut (16) 2" x 5 ½" rectangles for Block D.
H		SNOW DAY 52600D-1 Ice Blue	1	(8) 3" x WOF strips. Piece strips for length using diagonal seams. From the long strip, subcut the following: (2) 3" x 76 ½" Side Outer Borders. (2) 3" x 67 ½" Top/Bottom Outer Borders. (1) 4" x WOF strip. Subcut (16) 4" x 2" rectangles for Block D.
I		SNOW DAY 52600D-7 White	1 ¼	(3) 11 ½" x WOF strips. Piece strips for length using straight ¼" seams. From the long strip, subcut (2) 11 ½" x 60 ½" strips for Applique Assembly.
J		DIAMOND DUST 51394-2 Fire Engine	$\frac{7}{8}$	(3) 1 ½" x WOF strips. Subcut the following: (4) 1 ½" x 4 ½" rectangles for Block D. (8) 1 ½" x 4" rectangles for Block D. (8) 1 ½" x 3 ½" rectangles for Block D. (4) 1 ½" squares for Block D. (1) 2" x WOF strip. Subcut (16) 2" squares for Block D. <b>FOR BINDING:</b> (8) 2 ¼" x WOF strips for binding.
K		DIAMOND DUST 51394-17 Jade	$\frac{3}{4}$	(6) 2 ½" x WOF strips. Subcut the following: (6) 2 ½" x 4 ½" rectangles for Block B. (6) 2 ½" x 6 ½" rectangles for Block B. (6) 2 ½" x 8 ½" rectangles for Block B. (6) 2 ½" x 10 ½" rectangles for Block B. (4) 2 ½" x 4 ½" rectangles for Block D. (2) 1 ½" x WOF strips. Subcut (8) 1 ½" x 5 ½" rectangles for Block D. Using the remaining yardage, fuse (11) Template A pieces onto the wrong side of fabric. Cut out templates on the traced line and set aside for Applique Block assembly.
L		DIAMOND DUST 51394-26 Baby Blue	$\frac{3}{8}$	(1) 4 ½" x WOF strip. Subcut the following for Block C: (5) 4 ½" squares. (10) 2" squares. (4) 1 ½" x WOF strips. Subcut the following for Block C: (5) 1 ½" x 9" rectangles. (10) 1 ½" x 6" rectangles.

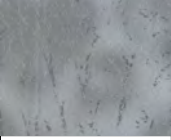

# Twinkle Lights

<b>M</b>		DIAMOND DUST 51394-39 Black	$\frac{3}{8}$	Using the available yardage, fuse (10) Template C pieces onto the wrong side of fabric. Cut out templates on the traced line and set aside for Applique Block assembly.
<b>N</b>		DIAMOND DUST 51394-41 Grey	$\frac{1}{4}$	Using the available yardage, fuse (30) Template B pieces onto the wrong side of fabric. Cut out templates on the traced line and set aside for Applique Block assembly.
		Backing	5	Batting 75" x 89", Fusible Web, Template Plastic Optional

WOF=WIDTH OF FABRIC, SNF=STITCH AND FLIP, HST=HALF SQUARE TRIANGLE, RST=RIGHT SIDES TOGETHER

**PROJECT DISCLAIMER:** Every effort has been made to ensure that all projects are error free. All the information is presented in good faith, however, no warranty can be given nor results guaranteed. Therefore, we assume no responsibility nor damages that may occur when referring to this pattern. When errors are brought to our attention, we make every effort to correct and post a revision as soon as possible. We suggest you check [windhamfabrics.com](http://windhamfabrics.com) for pattern updates and to test the pattern prior to making the project. Test templates first, before cutting all the pieces. Free projects are not for resale.



# Twinkle Lights

## PIECING INSTRUCTIONS

### BLOCK A:

1. Draw a diagonal line on the wrong side of (80) 2 ½" **Fabric A** squares.
2. Place (1) 2 ½" **Fabric A** square onto each corner of (1) 6 ½" **Fabric B** square, RST and edges aligned.
3. Sew along the drawn diagonal line on each square.
4. Trim the excess corner fabric from each square to a ¼" and press toward the corner to complete SNF techniques.

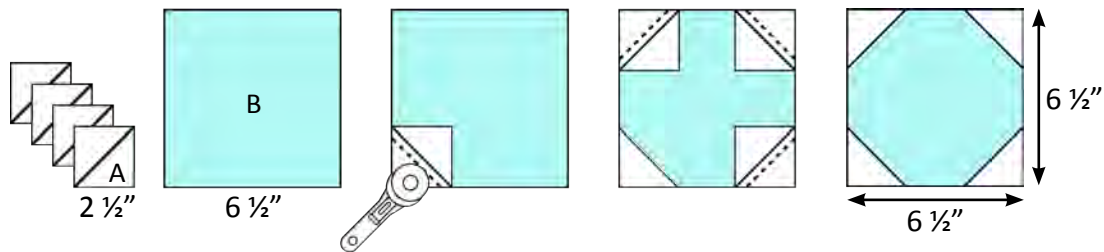

5. Repeat to create (10) Block A using **Fabric B** with **Fabric A** SNF corners, and (10) Block A using **Fabric C** with **Fabric A** SNF corners. Each Block A should measure 6 ½" x 6 ½" unfinished.

### Block A Examples

Make (10)  
**Fabric B**



Make (10)  
**Fabric C**



### BLOCK B:

6. Draw a diagonal line on the wrong side of (48) 2 ½" **Fabric A** squares.
7. Using 2 ½" **Fabric A** squares and the SNF techniques described above, SNF both top corners of (6) 2 ½" x 4 ½" **Fabric K** rectangles, (6) 2 ½" x 6 ½" **Fabric K** rectangles, (6) 2 ½" x 8 ½" **Fabric K** rectangles and (6) 2 ½" x 10 ½" **Fabric K** rectangles. This will complete tree branch unit assembly.

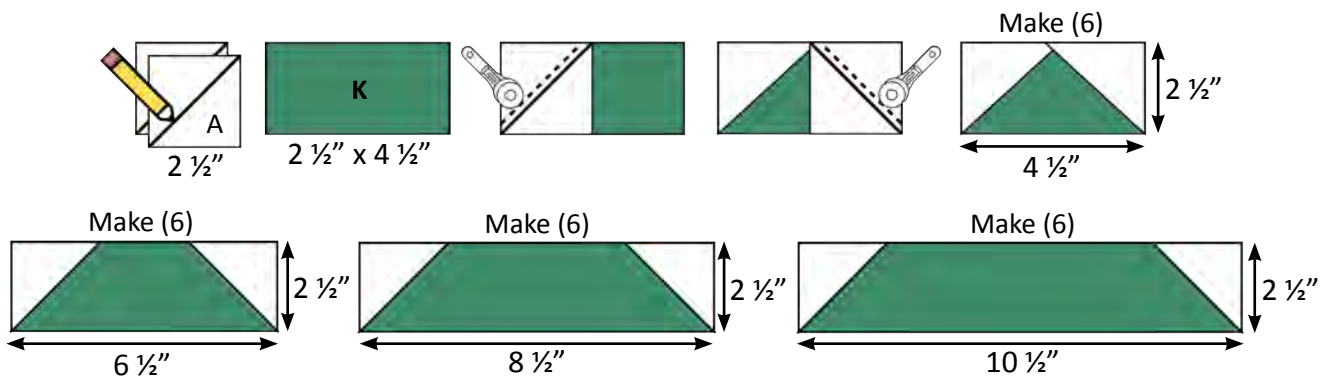

8. Arrange (1) of each tree branch unit size (*smallest tree branch at the top of Block B and progress in size moving downward*), (1) 1 ½" x 2 ½" **Fabric E** rectangle and **Fabric A** rectangles of varying size to form Block B. **Fabric A** rectangles are labeled for size in the diagram.

9. Sew Block B together in horizontal rows first, pressing seams away from the tree branch units. Sew horizontal rows together to complete Block B. Block B should measure 12 ½" x 12 ½" unfinished.

10. Repeat to create (6) Block B.



# Twinkle Lights

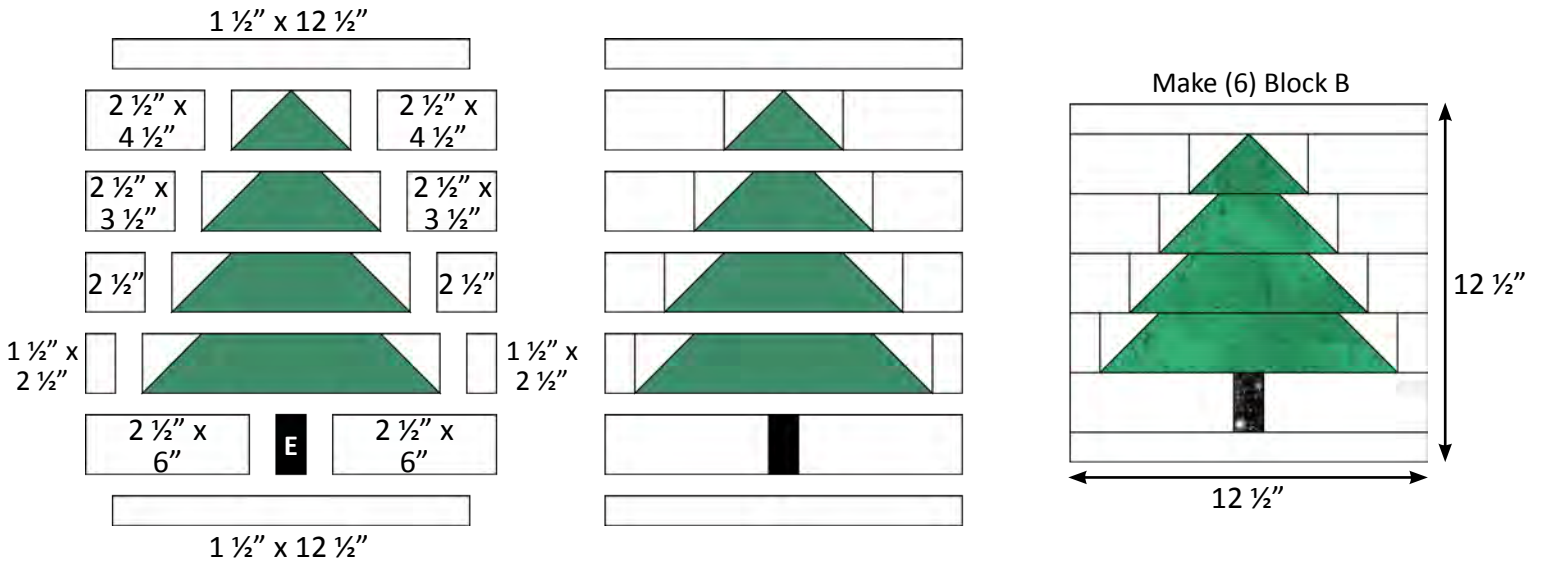

### BLOCK C:

11. Arrange (2) 4" x 6" **Fabric F** rectangles, (2) 4 1/2" x 6" **Fabric F** rectangles, (2) 1 1/2" x 6" **Fabric L** rectangles and (1) 1 1/2" x 9" **Fabric L** rectangle as shown to form the bottom of the gift box.
12. Sew together, pressing toward **Fabric F**. Once sewn, the gift box bottom unit should measure 12 1/2" x 9" unfinished.
13. Repeat to create (5) gift box bottom units for Block C.

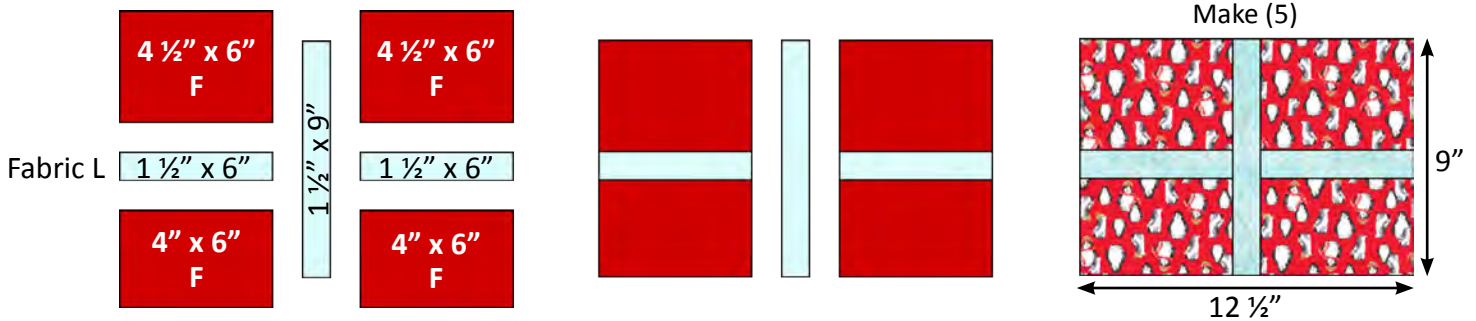

14. Draw a diagonal line on the wrong side of (5) 4 1/2" **Fabric A** squares.
15. Place each **Fabric A** square with a 4 1/2" **Fabric L** square, RST and edges aligned.
16. Sew a 1/4" away from either side of the drawn diagonal line on each set of squares.
17. Cut along the drawn diagonal line on each set of squares, creating a total of (10) HST units. Trim HST units to measure 4" x 4" unfinished.

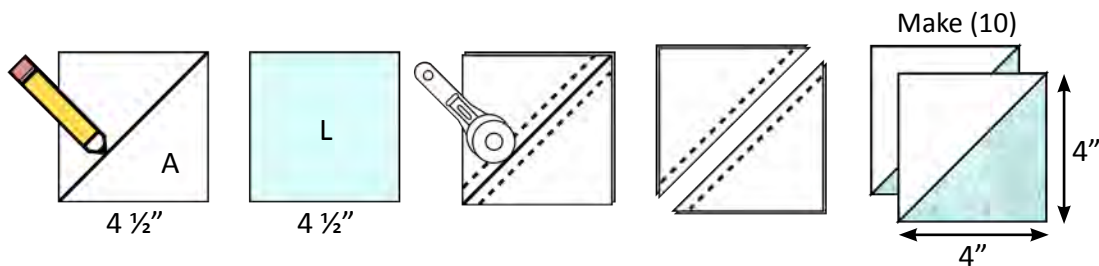



# Twinkle Lights

18. Draw a diagonal line on the wrong side of (10) 2" **Fabric L** squares.

19. Using 2" **Fabric L** squares and the SNF techniques described above, SNF the bottom left corners of (5) 2" x 4" **Fabric A** rectangles as shown for the left side of Block C. Then SNF the bottom right corners of (5) additional 2" x 4" **Fabric A** rectangles as shown for the right side of Block C. SNF units should be mirror images.

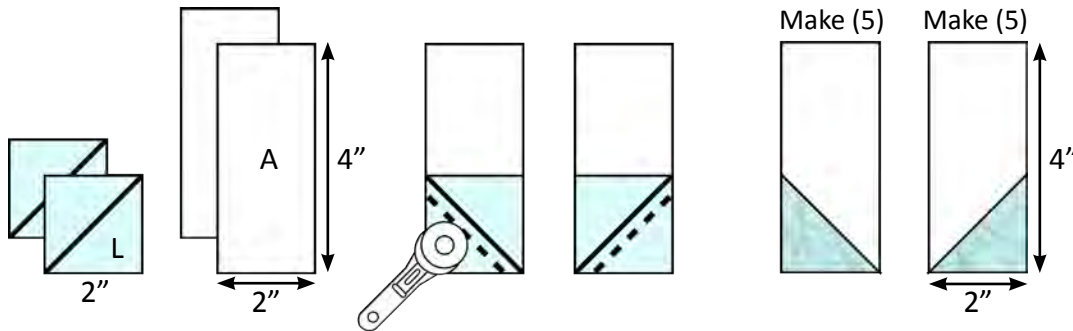

20. Arrange the gift box bottom unit, (2) HST units, (1) of each SNF unit created in Step 19 and (2) 1 1/2" x 4" **Fabric A** rectangles as shown to form Block C.

21. Sew Block C together. Once complete, Block C should measure 12 1/2" x 12 1/2" unfinished.

22. Repeat to create (5) Block C.

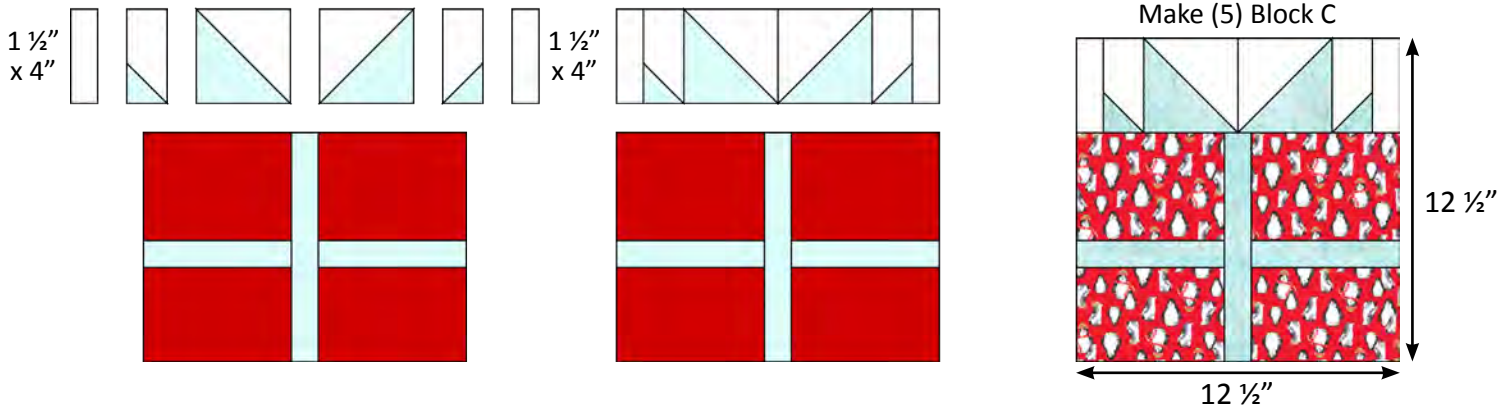

## BLOCK D:

23. Arrange (4) 2" x 5 1/2" **Fabric G** rectangles, (2) 1 1/2" x 5 1/2" **Fabric K** rectangles and (1) 2 1/2" x 4 1/2" **Fabric K** rectangle as shown to form the bottom of the gift box.

24. Sew together, pressing toward **Fabric G**. Once sewn, the gift box bottom unit should measure 12 1/2" x 4 1/2" unfinished.

25. Repeat to create (4) gift box bottom units for Block D.

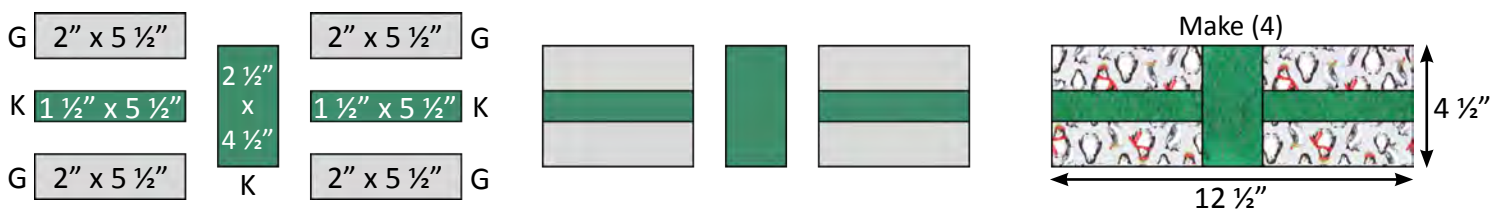



# Twinkle Lights

26. Arrange (4) 2" x 4" **Fabric H** rectangles, (2) 1 1/2" x 4" **Fabric J** rectangles, (1) 1 1/2" x 4 1/2" **Fabric J** rectangle and (2) 2 1/2" x 4 1/2" **Fabric A** rectangles as shown to form the middle of the gift box.

27. Sew together, pressing toward **Fabric H**. Once sewn, the gift box middle unit should measure 12 1/2" x 4 1/2" unfinished.

28. Repeat to create (4) gift box middle units for Block D.

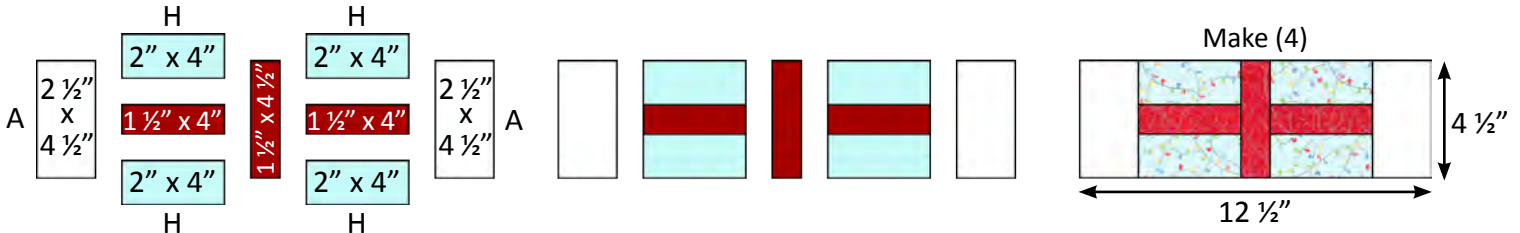

29. Draw a diagonal line on the wrong side of (16) 1 1/2" **Fabric A** squares, (8) 1" **Fabric A** squares and (16) 2" **Fabric J** squares.

30. Using 1 1/2" **Fabric A** squares and the SNF techniques described above, SNF the top left and bottom left corners of (8) 1 1/2" x 3 1/2" **Fabric J** rectangles as shown for the left and right sides of Block D.

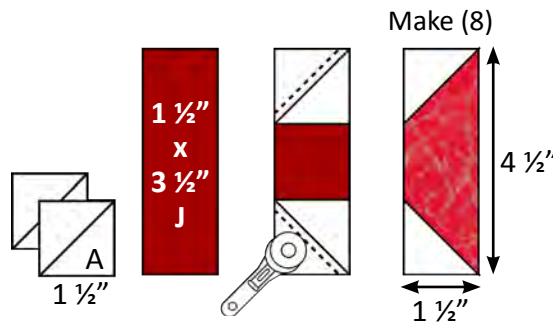

31. Using 2" **Fabric J** squares, SNF the bottom left corners of (4) 2 1/2" x 3" **Fabric A** rectangles to create units for the left side of Block D. Then SNF the bottom right corners of (4) additional 2 1/2" x 3" **Fabric A** rectangles to create units for the right side of Block D. SNF units should be mirror images.

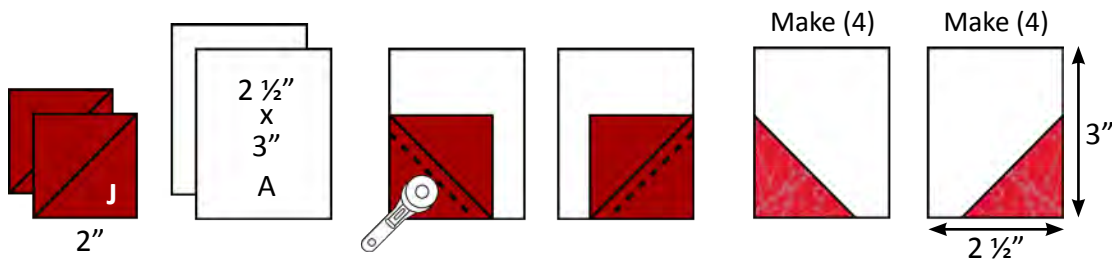

32. Using 2" **Fabric J** squares, SNF the top right corner of (4) 2 1/2" x 2" **Fabric A** rectangles to create units for the left side of Block D. Then SNF the top left corner of (4) additional 2 1/2" x 2" **Fabric A** rectangles to create units for the right side of Block D. SNF units should be mirror images.

33. Use (1) 1" **Fabric A** square to SNF the same corner (corner where **Fabric J** is located) of each SNF unit created in Step 32. SNF units should be mirror images.

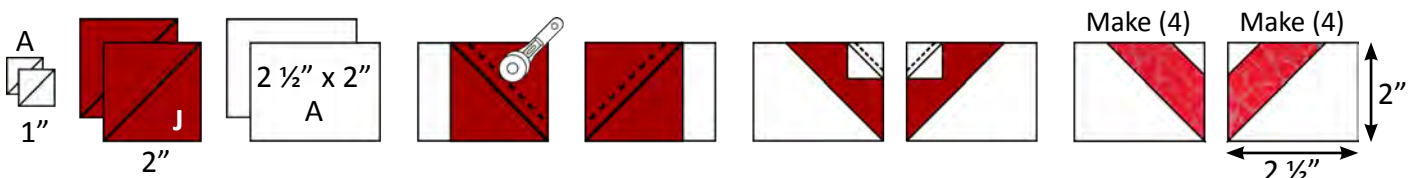





# Twinkle Lights

**34.** Arrange the gift box bottom unit, gift box middle unit, (2) SNF units created in Step 30, (2) mirror image SNF units created in Step 31, (2) mirror image SNF units created in Steps 32-33, (1) 1 1/2" **Fabric J** square and assorted **Fabric A** rectangles. **Fabric A** rectangles are labeled for size.

**35.** Sew Block D together. Once complete, Block D should measure 12 1/2" x 12 1/2" unfinished.

**36.** Repeat to create (4) Block D.

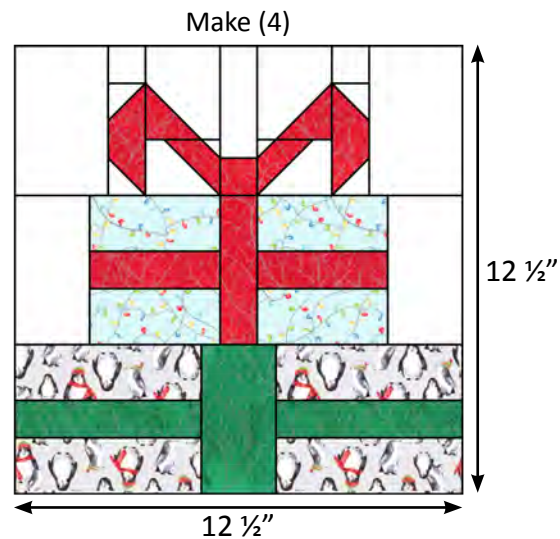
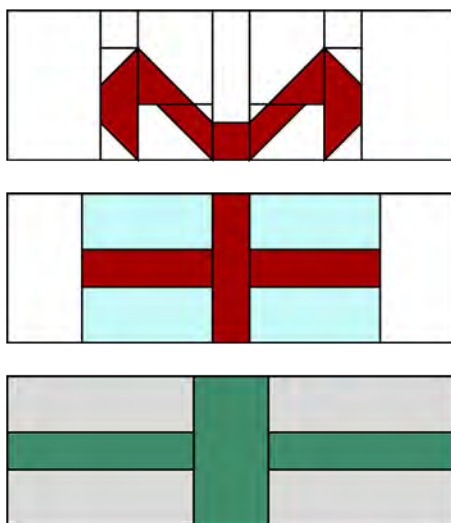
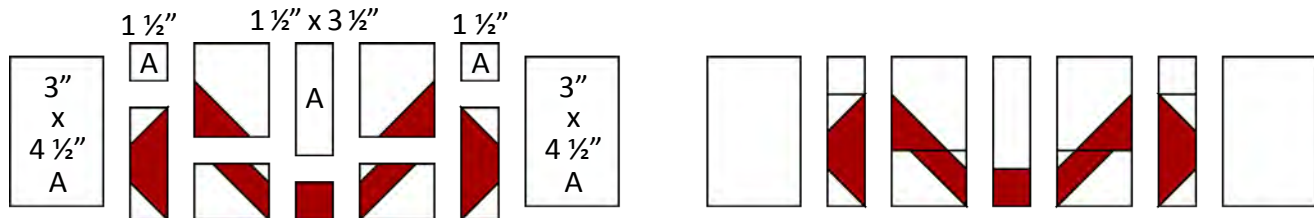

## APPLIQUE BLOCKS:

**37.** Remove the paper from the glue side of all Templates A-C.

**38.** To create (2) applique blocks, arrange **Fabric M** Template C pieces in a wavy formation onto (2) 11 1/2" x 60 1/2" **Fabric I** strips as shown. The ends of the Template C pieces should overlap slightly to create a seamless transition. Template C pieces should stop a 1/4" from either end of the 11 1/2" x 60 1/2" **Fabric I** strips so that it's not included in the seam allowance.

**39.** Once you are satisfied with the placement of each **Fabric M** Template C, fuse in place and stitch down using the thread color and decorative stitch of your choice. Stitch the intersections where the Template C pieces are overlapped to secure.

**40.** Second, place the Template A pieces cut from **Fabrics D** and **K** onto the 11 1/2" x 60 1/2" **Fabric I** strips. Place Template A pieces so that there is approximately 1/4" between the Template A and C pieces. Templates should not overlap, but instead will be connected by **Fabric N** Template B pieces in the next step.

**41.** Last, place the **Fabric N** Template B pieces. Template B pieces should connect Templates A and C and overlap both templates on top.

**42.** Once you are satisfied with the placement of Templates A and B, fuse in place and stitch down using the thread color and decorative stitch of your choice.



# Twinkle Lights

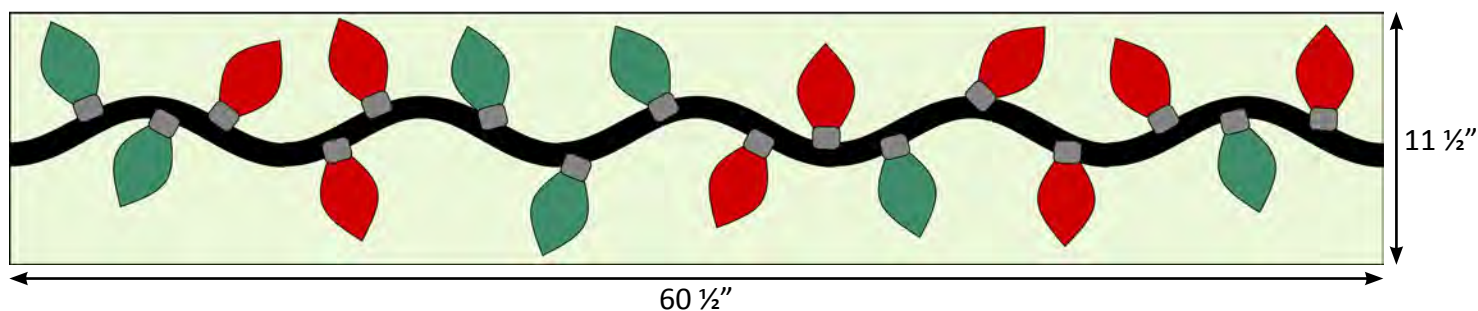
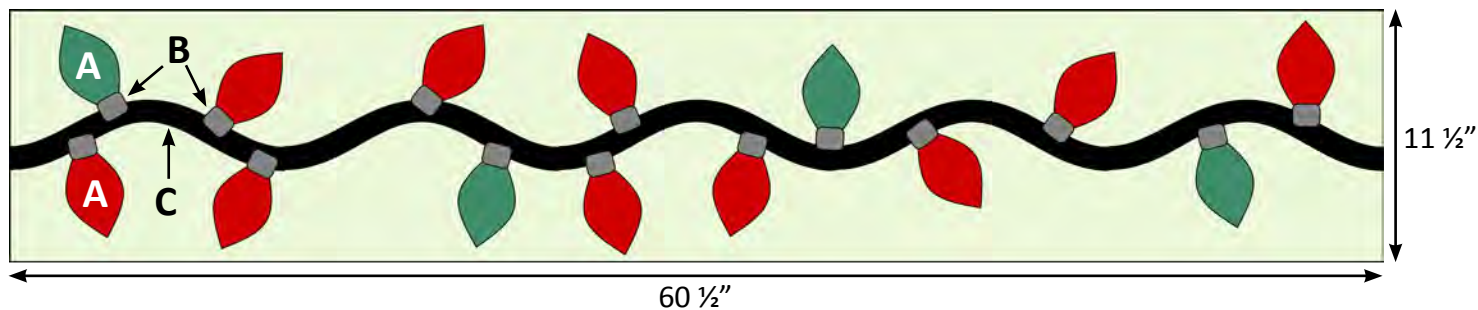

## QUILT ASSEMBLY

43. Arrange Blocks A-D, the Applique Blocks and (2) 2 1/2" x 60 1/2" **Fabric A** strips as shown to form the quilt top center. Block A rows should alternate between Block A colorways. Block rows containing Blocks B-D should alternate between block types as shown in the diagram.

44. Sew the blocks into horizontal rows.

45. Sew horizontal rows together, pressing toward the Applique Blocks and **Fabric A** strips to complete the quilt top center. The quilt top center should measure 60 1/2" x 74 1/2" unfinished.



# Twinkle Lights



2 1/2" x 60 1/2"

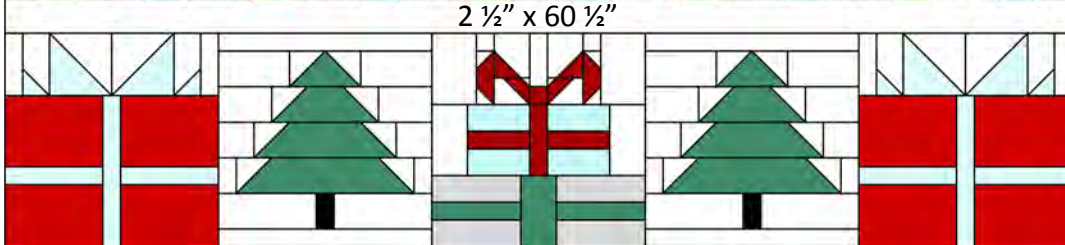
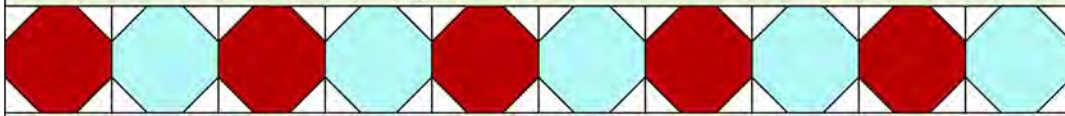
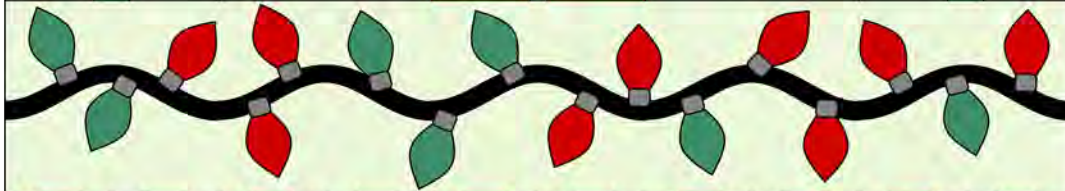
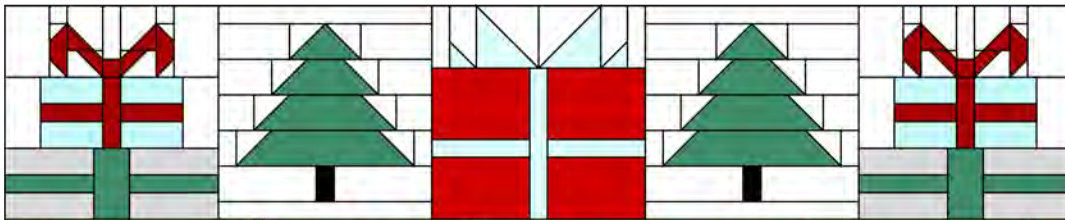
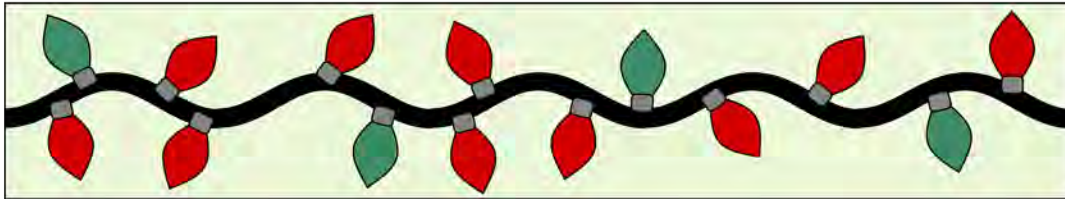
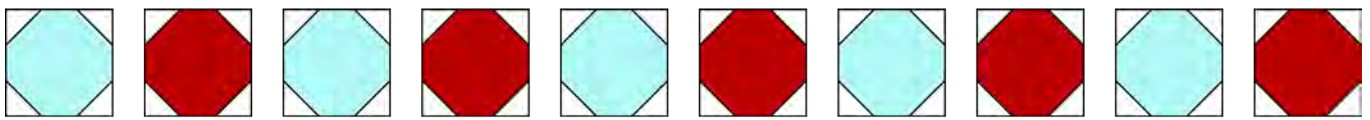

2 1/2" x 60 1/2"



# Twinkle Lights

- 46. Attach (1) 1 ½" x 74 ½" **Fabric A** Side Inner Border to either side of the quilt top center. Press outward.
- 47. Attach (1) 1 ½" x 62 ½" **Fabric A** Top/Bottom Inner Border to the top and bottom of the quilt top center. Press outward. Quilt top should measure 62 ½" x 76 ½" unfinished at this step.
- 48. Attach (1) 3" x 76 ½" **Fabric H** Side Outer Border to either side of the quilt top. Press outward.
- 49. Attach (1) 3" x 67 ½" **Fabric H** Top/Bottom Outer Border to the top and bottom of the quilt top. Press outward to complete quilt top assembly. The quilt top should measure 67 ½" x 81 ½" unfinished.

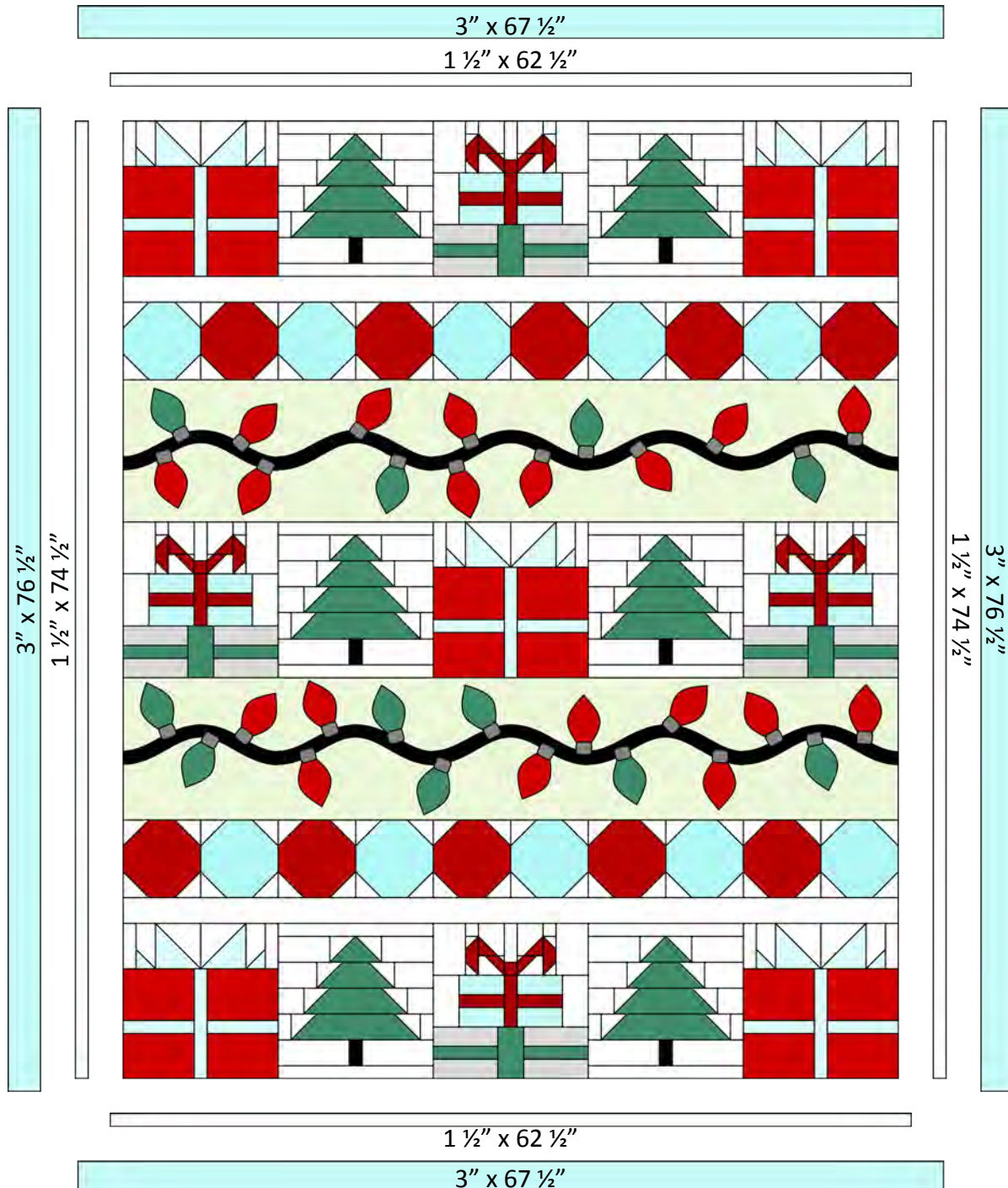



# Twinkle Lights

## FINISHING THE QUILT:

50. Sandwich quilt top with batting and backing. Baste quilt layers together using your preferred method. Quilt as desired.

51. Create binding using (8) **Fabric J** 2 ¼" x WOF strips.

52. Attach binding using your preferred method.

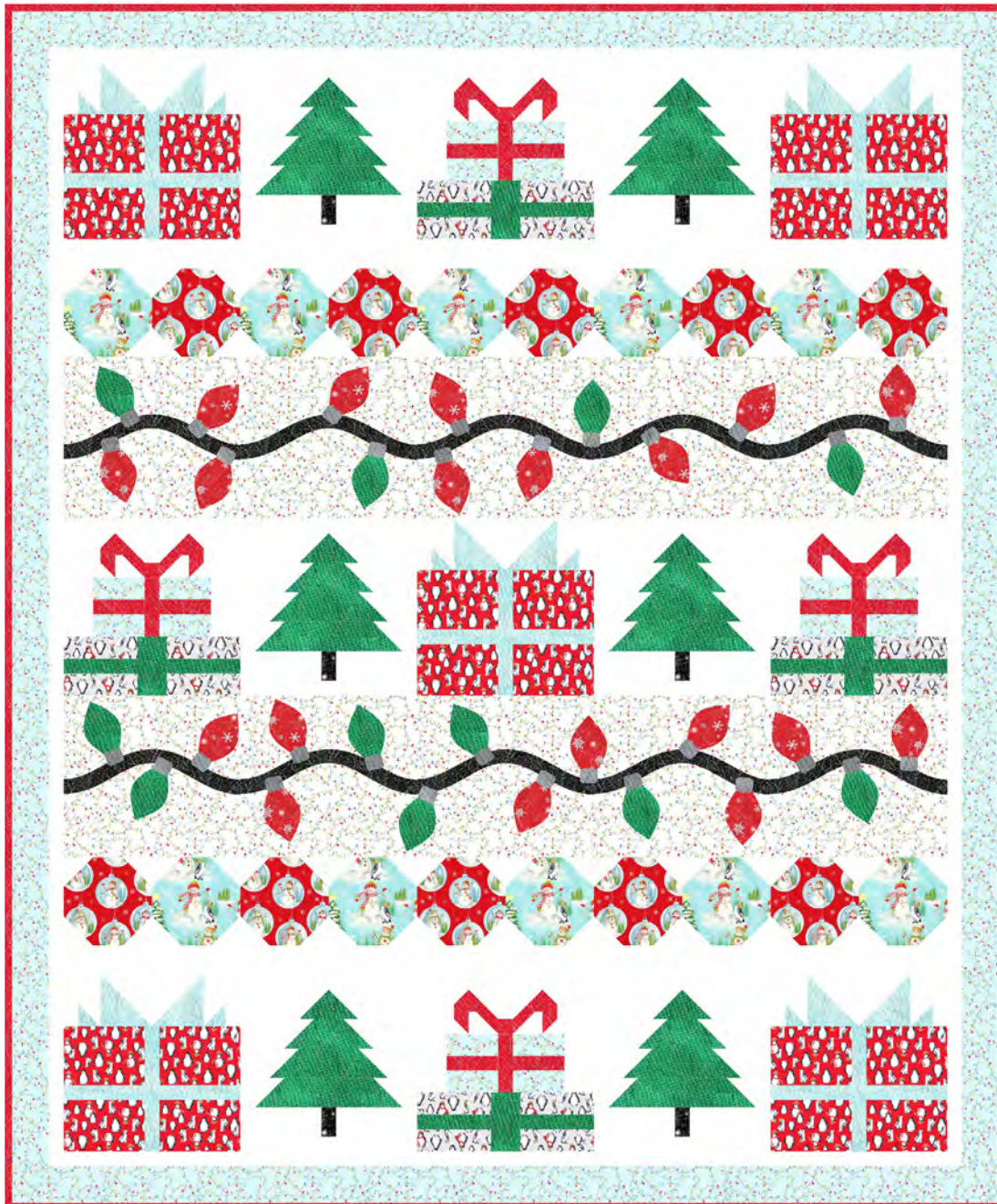



# Twinkle Lights Templates

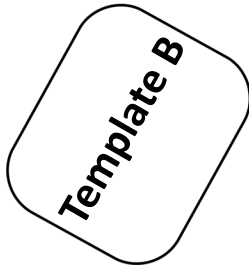

Template B

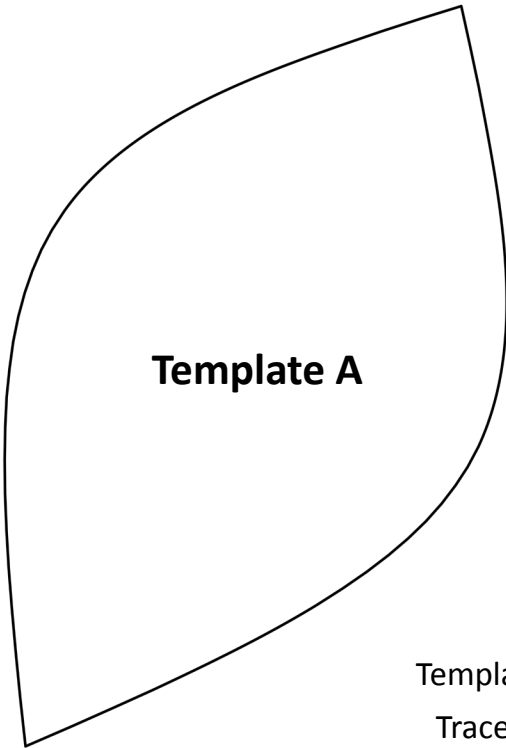

Template A

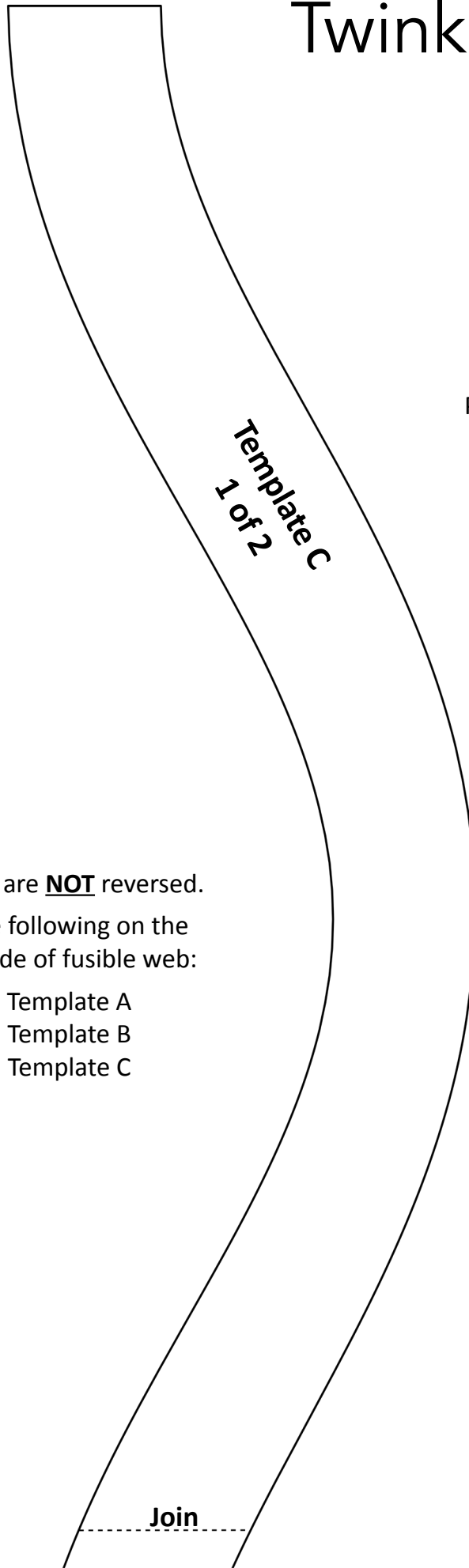

Template C  
1 of 2

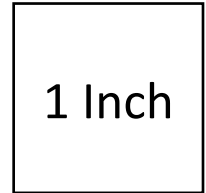

1 Inch

Print Templates  
at 100% or  
Actual Size.

Templates are **NOT** reversed.

Trace the following on the  
smooth side of fusible web:

- (30) Template A
- (30) Template B
- (10) Template C

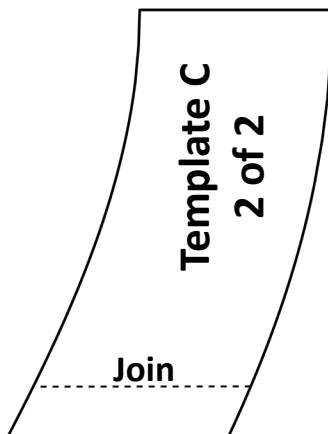

Template C  
2 of 2

Join

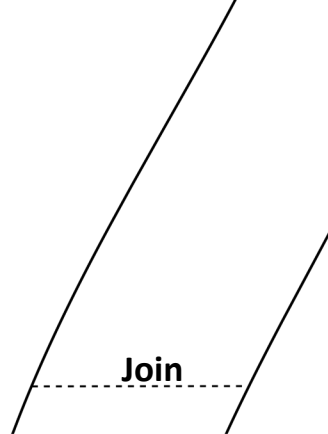

Join